

- FR** Notice de Montage - Utilisation - Entretien
- ES** Instrucciones de Montaje, Utilización y Mantenimiento
- PT** Instruções de Montagem, Utilização e Manutenção
- IT** Istruzioni per il Montaggio, l'Uso e la Manutenzione
- EL** Εγχειρίδιο συναρμολόγησης, χρήσης και συντήρησης
- PL** Instrukcja Montażu, Użytkowania i Konserwacji
- RU** Руководство По Сборке и Эксплуатации
- UK** Керівництво По Збірці і Експлуатації
- RO** Manual asamblare, utilizare și întreținere
- EN** Assembly - Use - Maintenance Manual

EAN CODE : 3276000239789

Filtre à particules / Filtro de partículas / Filtro de partículas / Filtro antiparticolato /  
Filtr czastek / Фильтр для частиц / Фильтр для часток / Filtru de particule / Partide filter

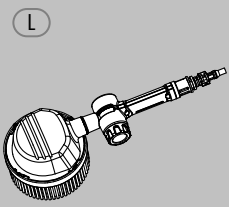

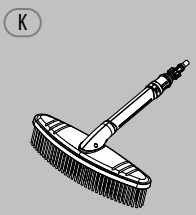
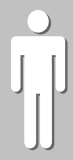
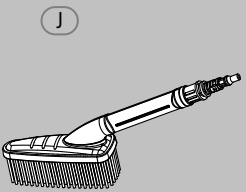
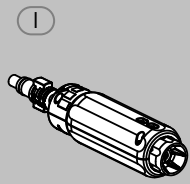
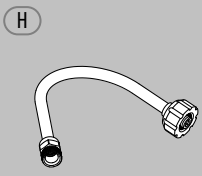
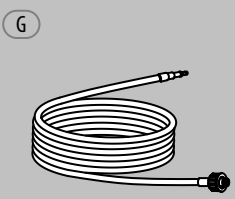
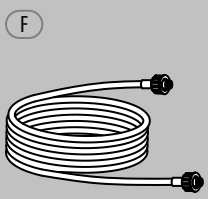
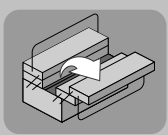
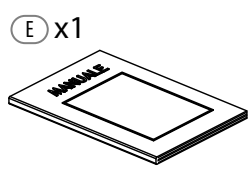
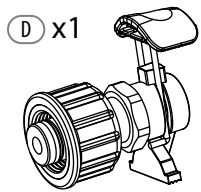
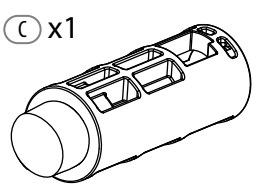
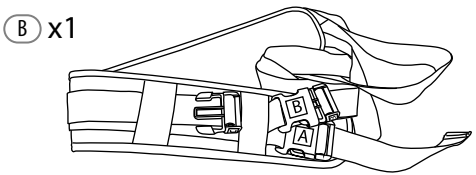
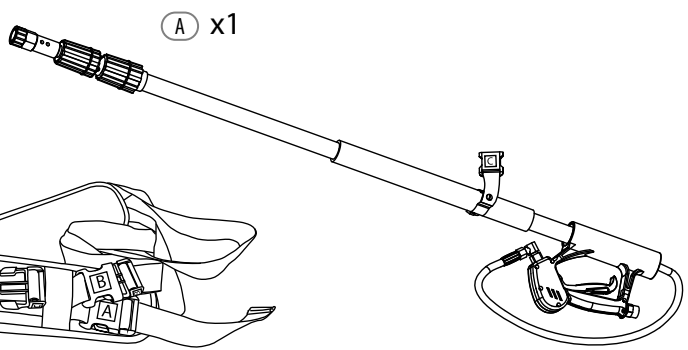
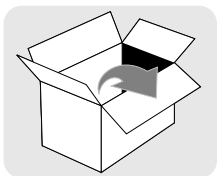



Attention danger / Atención: Peligro / Atenção perigo / Attenzione pericolo / Προσοχή κίνδυνος / Uwaga niebezpieczeństwo / Внимание! Опасно! / Увага! Небезпечно! / Atenție, pericol / Caution danger



Observez / Atención / Aviso / Osservare / Προσέξτε / Przestrzegać / Соблюдайте правила техники безопасности / Дотримуйтеся правил техніки безпеки / Respectați / Observe



Correct / Correcto / Correcto / Corretto / Σωστό / Dobrze / Правильный / Правильно / Corect / Correct



Incorrect / Incorrecto / Incorrecto / Errato / Λάθος / źle / Неправильный / Неправильно / Incorect / Incorrect

**Notes / Observaciones / Notas / Note /  
Σημειώσεις / Notatki / Примечания /  
Примітки / Note / Notes**

---

---

---

---

---

---

---

---

---

---

**A**

FR Montage

ES Montaje

PT Montagem

IT Montaggio

EL Συναρμολόγηση

PL Montaż

RU Сборка

UK Збірка

RO Montaj

EN Assembly

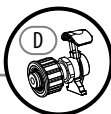
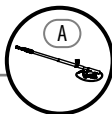
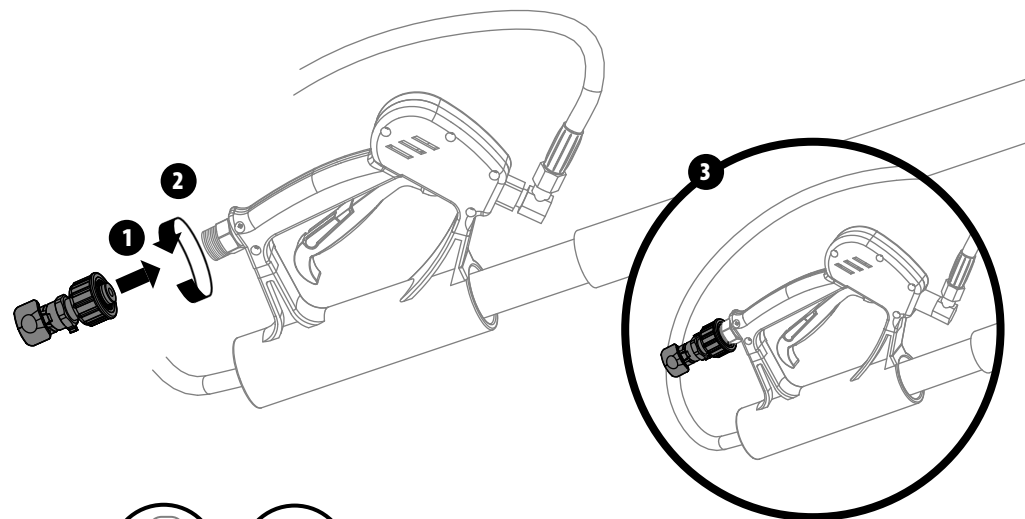
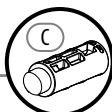
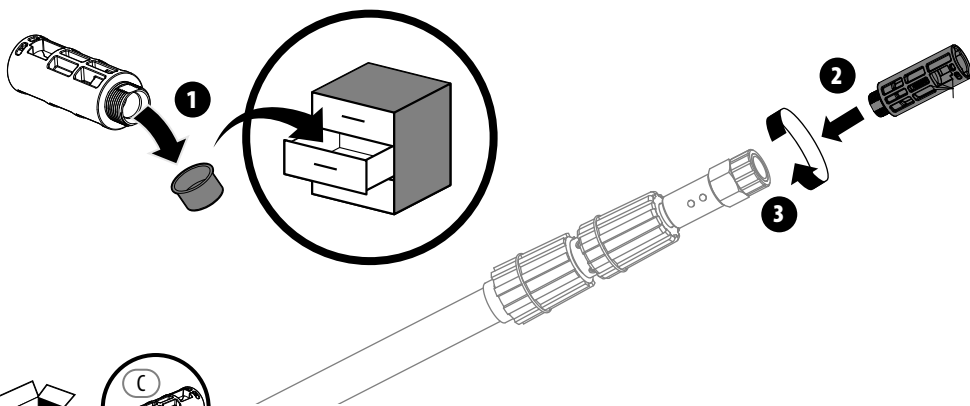
**1****2**

FR Montage

ES Montaje

PT Montagem

IT Montaggio

EL Συναρμολόγηση

PL Montaż

RU Сборка

UK Збірка

RO Montaj

EN Assembly

A

3

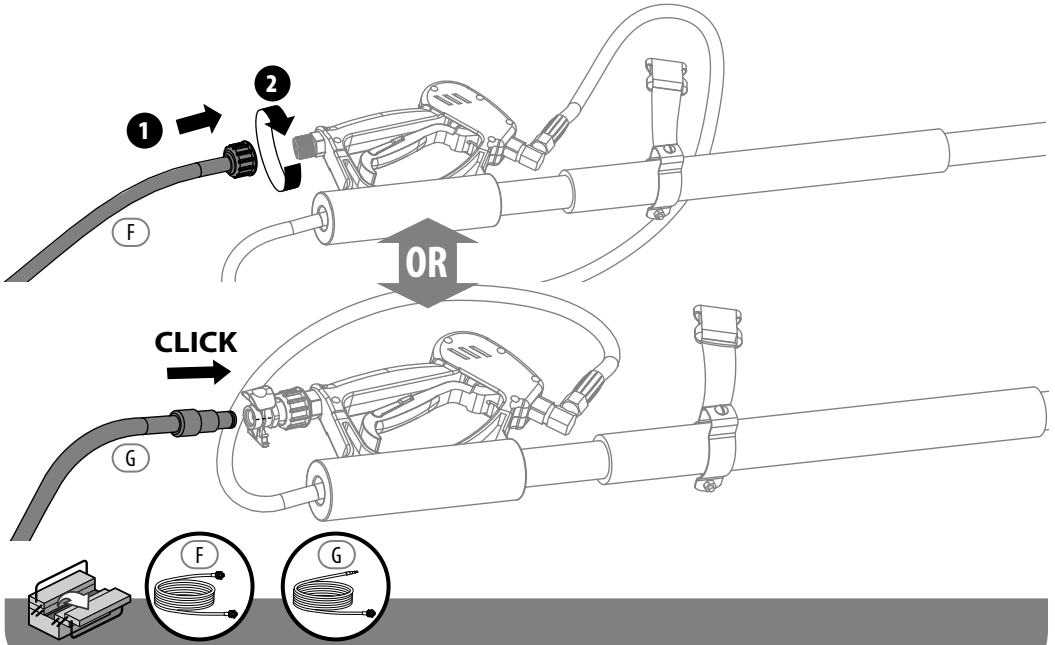

4

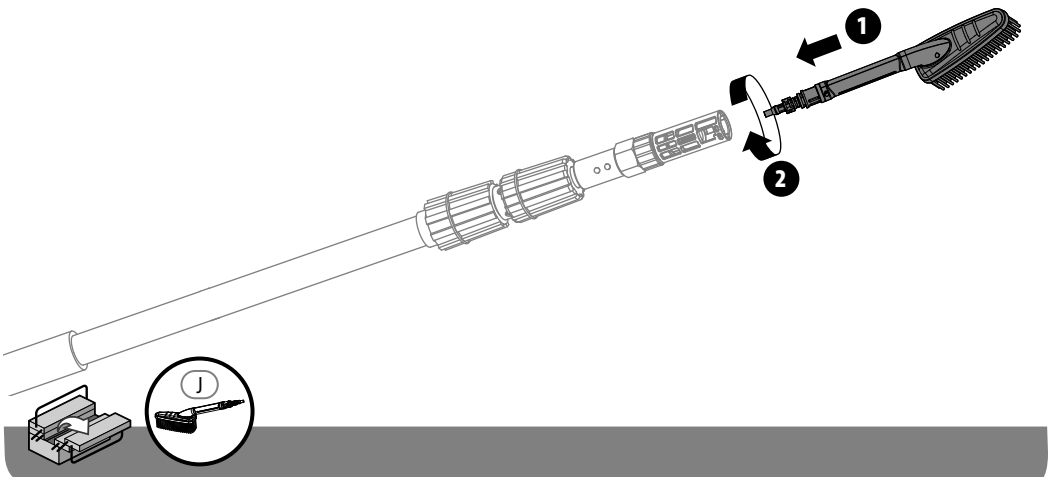

**A**

FR Montage

ES Montaje

PT Montagem

IT Montaggio

EL Συναρμολόγηση

PL Montaż

RU Сборка

UK Збірка

RO Montaj

EN Assembly

A

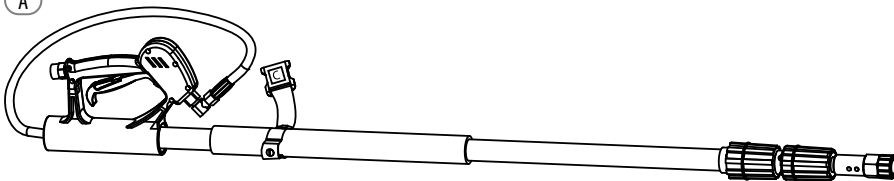

D

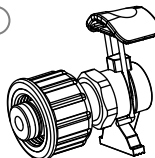

GENERATION 2

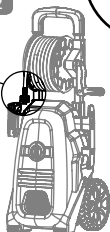

135

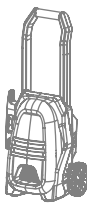

120

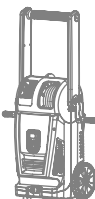

150C

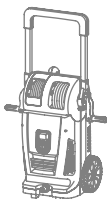

160C

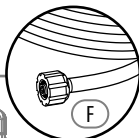

F

GENERATION 3



160HR.3



150HR.3



150C.3



G

FR Montage

ES Montaje

PT Montagem

IT Montaggio

EL Συναρμολόγηση

PL Montaż

RU Сборка

UK Збірка

RO Montaj

EN Assembly

A

H



EAN CODE : 3276000240211

C

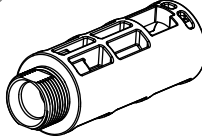

I

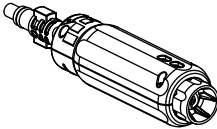

EAN CODE : 3276000239802

J

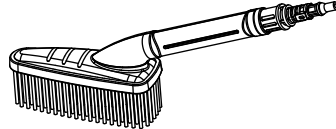

EAN CODE : 3276000239833

K

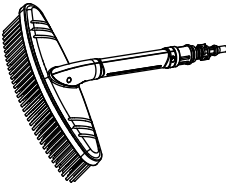

EAN CODE : 3276000239918

L

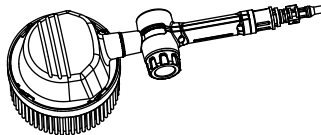

EAN CODE : 3276000239840

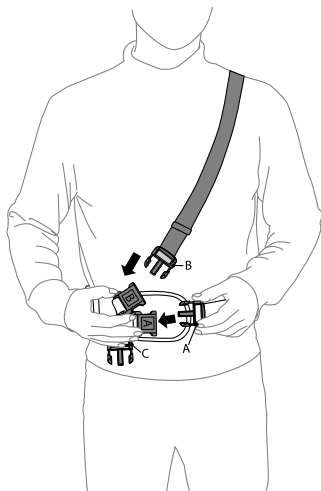
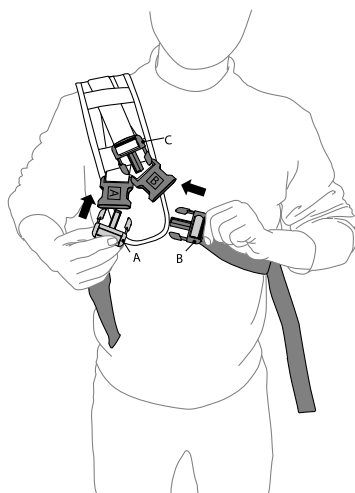
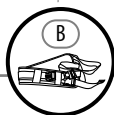
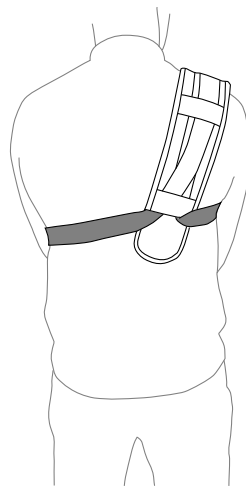
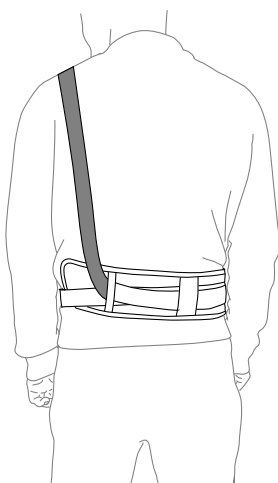
**A****FR** Montage**ES** Montaje**PT** Montagem**IT** Montaggio**EL** Συναρμολόγηση**PL** Montaż**RU** Сборка**UK** Збірка**RO** Montaj**EN** Assembly**5****1****2****OR**



FR Montage

ES Montaje

PT Montagem

IT Montaggio

EL Συναρμολόγηση

PL Montaż

RU Сборка

UK Збірка

RO Montaj

EN Assembly

A

6

1

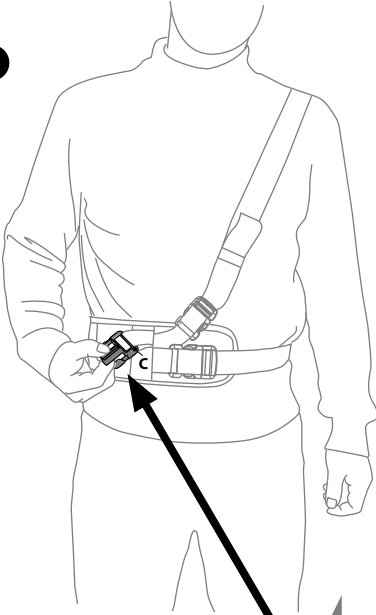

2

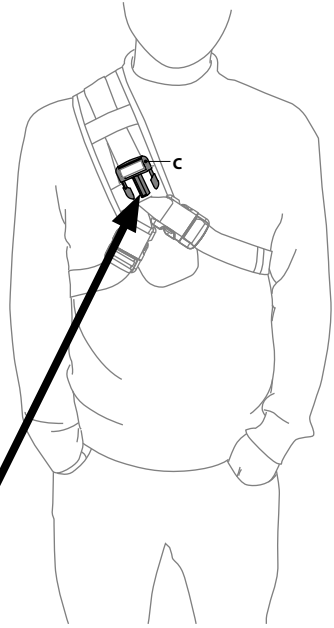

OR

CLICK

CLICK

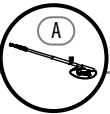
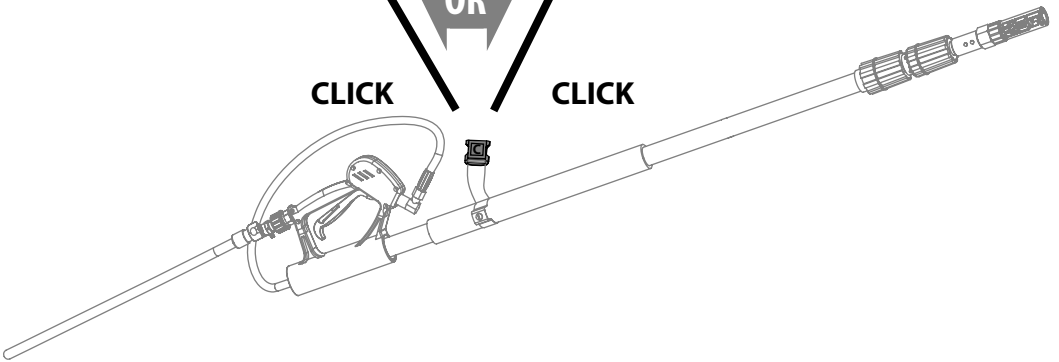

**B**

FR Utilisation

ES Utilización

PT Utilização

IT Uso

EL Χρήση















PL Użytkowanie

RU Использование

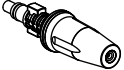
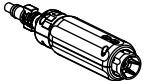
UK Використання

RO Utilizare

EN Use

							
 EAN CODE : 3276000239819	•	•	•	•	•	•	•
 EAN CODE : 3276000239796	•		•		•		
 EAN CODE : 3276000239802	•	•	•	•	•	•	•
 EAN CODE : 3276000239826			•				•
 EAN CODE : 3276000239918	•	•	•		•		•
 EAN CODE : 3276000239840	•	•	•		•		•
 EAN CODE : 3276000239833	•	•	•		•		•
 EAN CODE : 3276000239901			•				•

FR Utilisation

ES Utilización

PT Utilização

IT Uso

EL Χρήση

PL Użytkowanie

RU Использование

UK Використання

RO Utilizare

EN Use

C

1

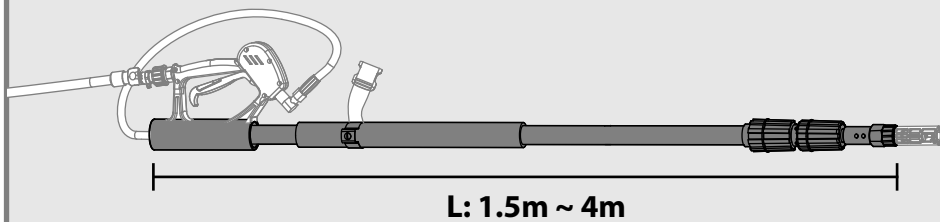

2

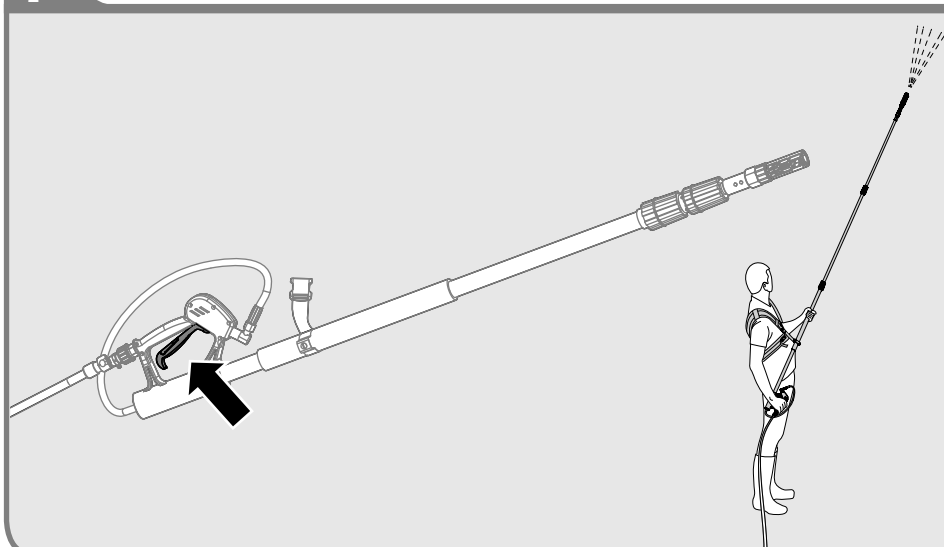

# D

- FR Entretien
- ES Mantenimiento
- PT Serviço
- IT Manutenzione
- EL Συντήρηση
- PL Konserwacja
- RU Уход
- UK Догляд
- RO Întreținere
- EN Maintenance

1

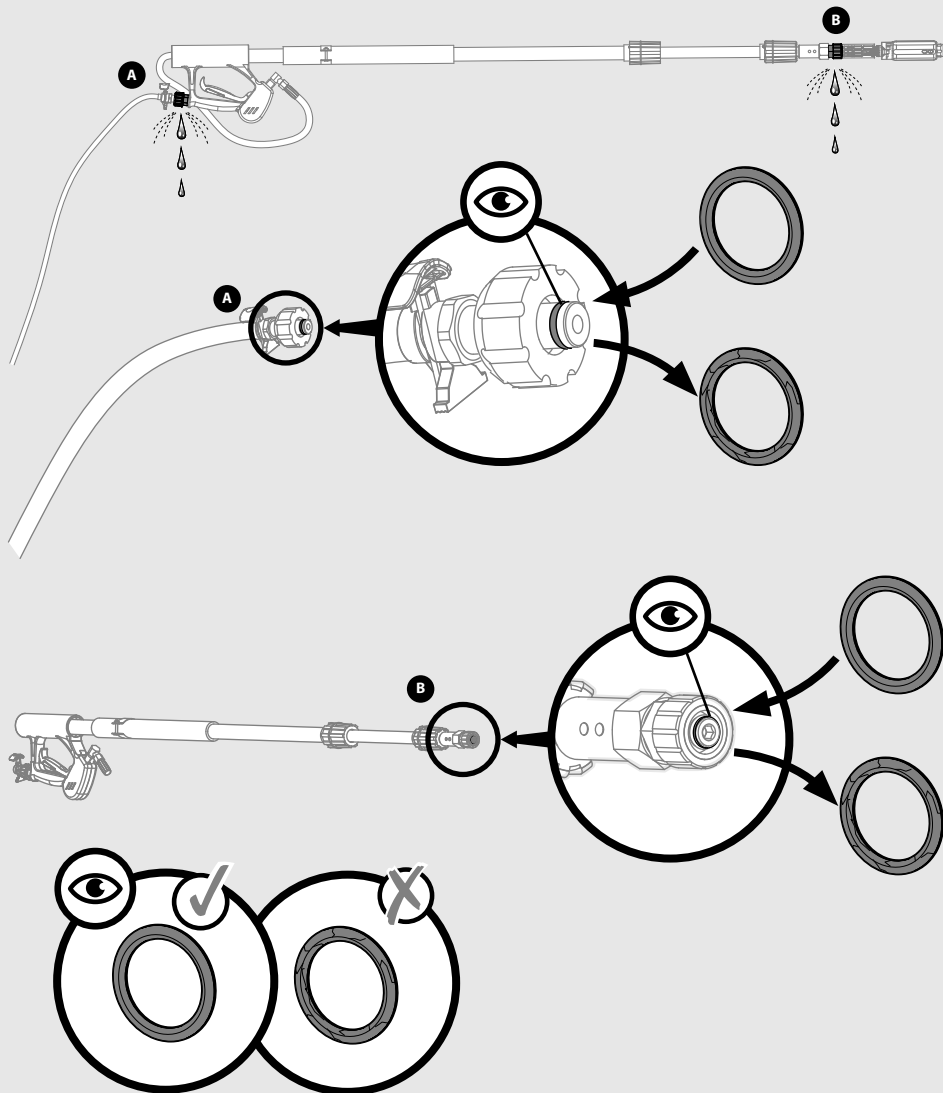

FR Hivernage

ES Durante el invierno

PT Preparação para o inverno

IT Rimessaggio

EL Αποθήκευση το χειμώνα

PL Przechowywanie

RU Зимний период

UK Зимовий період

RO Păstrare pe perioada iernii

EN Winter storage

E

1

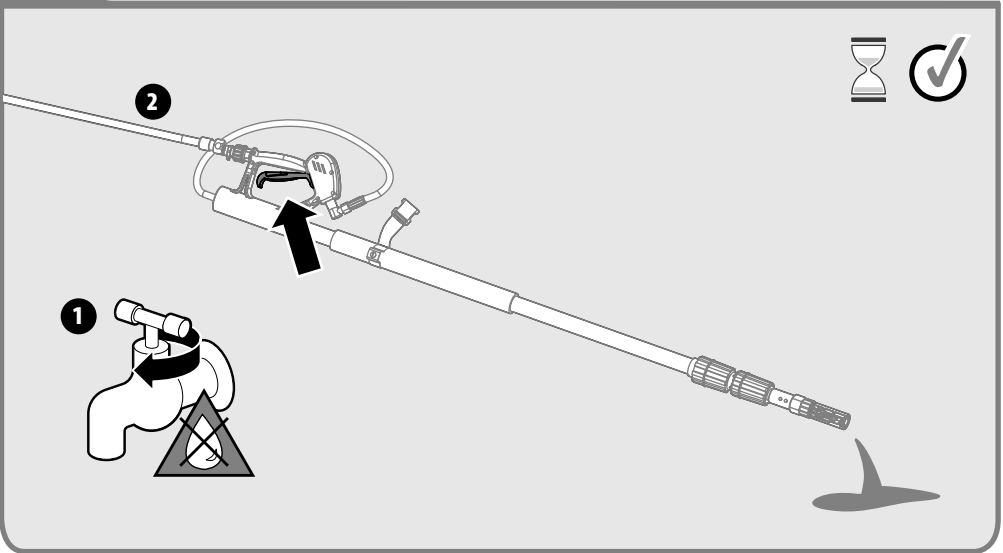

2

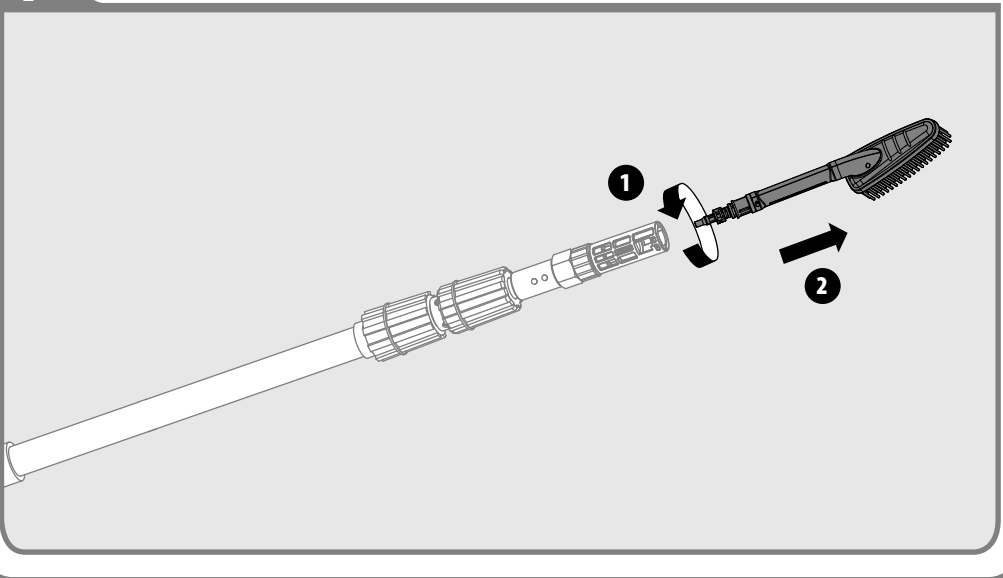

**E**

FR Hivernage

EL Αποθήκευση το χειμώνα

RO Păstrare pe perioada iernii

ES Durante el invierno

PL Przechowywanie

EN Winter storage

PT Preparação para o inverno

RU Зимний период

EN Winter storage

IT Rimessaggio

UK Зимовий період

3

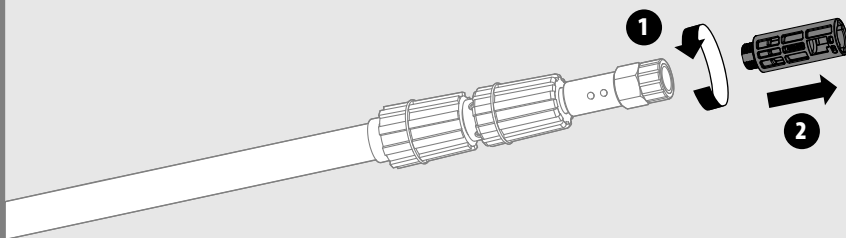

4

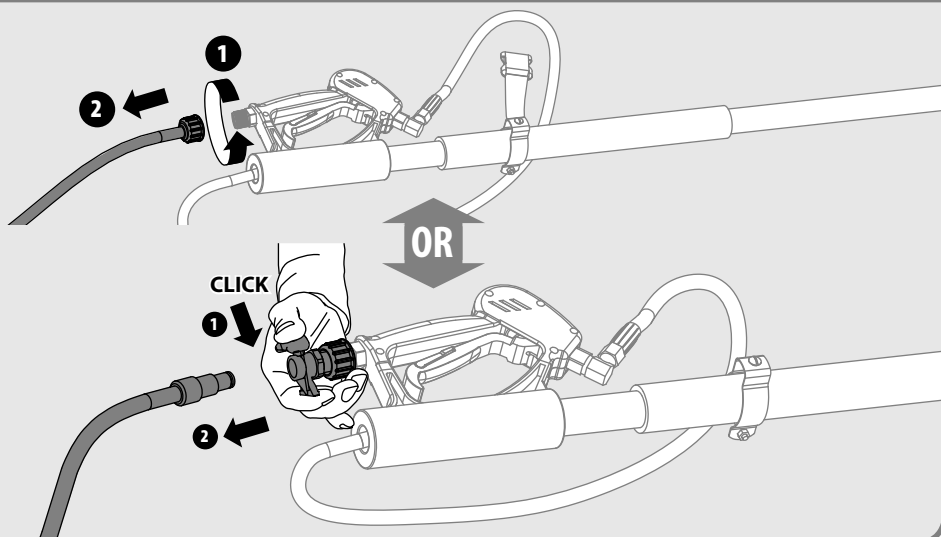

FR Hivernage

EL Αποθήκευση το χειμώνα

RO Păstrare pe perioada iernii

ES Durante el invierno

PL Przechowywanie

EN Winter storage

PT Preparação para o inverno

RU Зимний период

IT Rimessaggio

UK Зимовий період

E

5

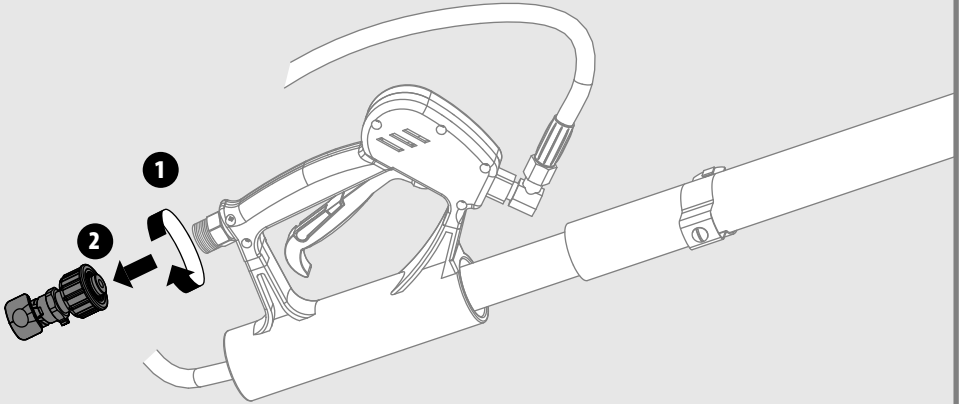

6

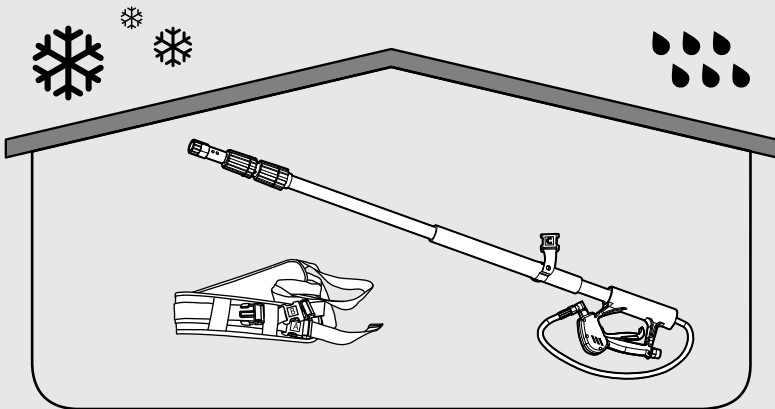



**FR** ADEO Services - 135 Rue Sadi Carnot - CS 00001  
59790 RONCHIN - France

**RU** ООО ЛЕРУА МЕРЛЕН ВОСТОК, 141031, Московская область,  
Мытищинский район, г. Мытищи, Осташковское шоссе,  
д.1, РОССИЯ

**UA** ТОВ «Леруа Мерлен Україна»,  
вул. Полярна 17а, м. Київ 04201, Україна